



DRILLSTAR

DRILLING TOOLS CATALOG

Stabilization - Borehole Enlargement



www.drillstar.fr

Downhole Innovations, Made in France



Z-REAMER	3
X-REAMER	5
HOLE OPENER	7
PDC HOLE OPENER	9
INTEGRAL BLADE STABILIZER	11
ROLLER REAMER	13

Z-REAMER

Your advanced compact underreamer

Designed with simplicity and reliability in mind, the Drillstar Z-Reamer is a compact block-type underreamer featuring advanced reaming capabilities. Its long blades provide unique cutter density and optimized stability, while its compact size opens up new reaming applications.

One size up

The Z-reamer is the first block-type underreamer capable of enlarging one bit size up (or about 50% of pilot size) even in the smaller diameters. This unique feature enables the tool to be run in directional casing-while-drilling and other demanding applications.

Near-bit directional reaming

As the Z-Reamer can be located immediately above the bit, long ratholes are no longer required, saving rig time and reducing drilling risks. The Z-Reamer is compact enough to be run below a mud motor or a point-the-bit RSS in directional applications.

Improved drilling performances

Unlike a bicenter bit, the Z-reamer is a fully centered tool, reducing drilling vibrations and improving stability. When run near-bit, the reaming blades are always in the same formation as the bit, improving the drilling performances.

Simple and precise activation

If required, the Z-Reamer can be activated by pressure using specially designed shear pins. This makes the activation possible even below BHA components such as mud motor, RSS, etc. Activation pressure can be adjusted on site.

Field maintainable

The Z-reamer is a sturdy tool, tested to perform in harsh drilling environments while remaining simple enough to be maintained in the field with few spare parts and hand tools, reducing turnaround time and improving reliability.

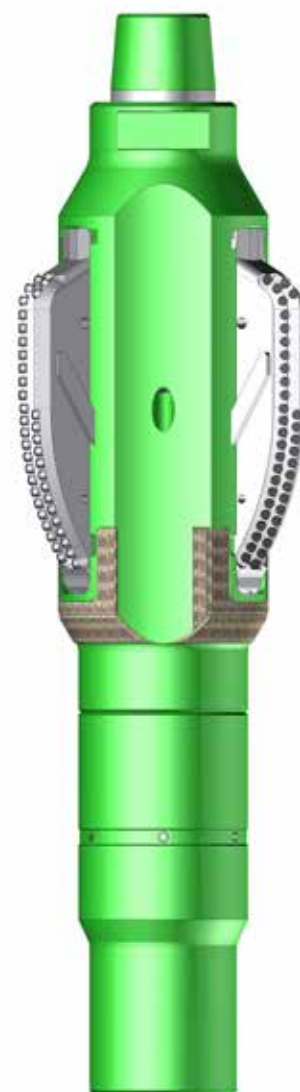

Z1225H with blades extended to 17 1/2"



Z-REAMER

Fail-safe design

The Z-reamer does not rely on any mechanical lock to remain open while drilling. The reaming blades are kept open by WOB and hydraulics, and retract once the pumps are stopped and the BHA is picked up from bottom. The blades shape prevents them from being pulled away from the body, strongly reducing the risk of losing any component downhole.

Optimized for your well

Reaming blades design can be optimized for your formation and desired well trajectory. Matching Z-Reamer blades & drilling bits can be delivered thanks to our partnership with major bit manufacturer Varel. Advanced computer analysis for directional behaviour, modal analysis and hydraulics can be conducted to select the best BHA components and drilling parameters.

Standard dimensions

Type	Nominal Pilot Bit Size	Max Body OD	Opening Range	Max Flow Rate (GPM)	Standard Connections
Z350H	3 5/8" - 3 7/8"	3 1/2"	3 3/4" - 5"	150	2 3/8" REG / IF
Z450H	4 1/2"	4 3/8"	4 3/4" - 6 3/8"	250	2 7/8" REG / IF
Z600H	5 7/8" - 6"	5 3/4"	6 1/4" - 8 1/2"	450	3 1/2" REG / IF
Z850H	8 1/2"	8 1/4"	8 3/4" - 12 1/4"	900	4 1/2" REG / IF
Z1000H	10 3/8"	10"	10 1/4" - 14"	1800	6 5/8" REG
Z1225H	12 1/4"	11 3/4"	12 1/4" - 17 1/2"	1800	6 5/8" REG
Z1750H	17 1/2"	16 3/4"	17 1/2" - 23"	1800	7 5/8" REG

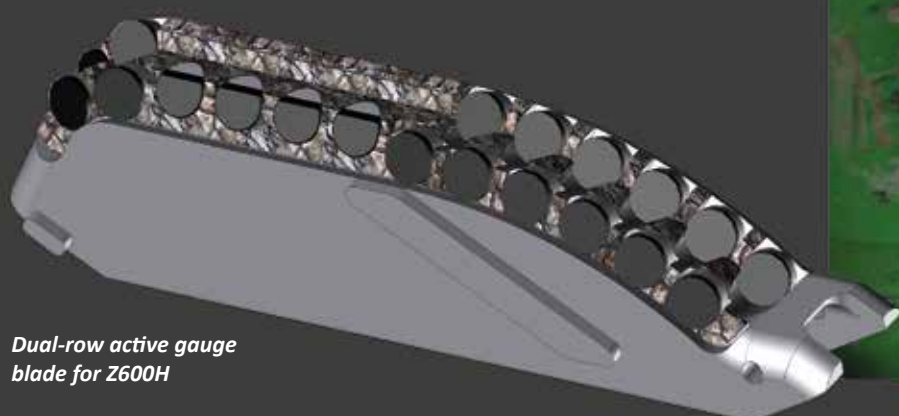

Dual-row active gauge blade for Z600H



Downhole Innovations, Made in France

X-REAMER

XL reaming through XS clearances

The X-Reamer has proven itself as a reliable and efficient solution for enlarging the borehole beyond bit diameter. Combining a flip-arms expansion mechanism with unique stabilization features, the X-reamer is capable of enlarging over 100% of the pilot hole size, making it the tool of choice for gravel pack installation, window reaming, plugging or gas storage applications.

Each body can be fitted with any size of arms within its opening range. Extra arms can be manufactured and delivered worldwide on short notice.

Custom bodies can also be manufactured to accommodate different hole IDs.

Unique cutting structure

The X-reamer cutting arms feature two rows of premium PDC cutters, for improved ROP and downhole time. Their shape has been designed to maximize stabilization and reduce the effect of lateral impacts on PDC cutters by presenting a large, passive gauge structure.

Improved pilot stability

Hardfaced stabilizing pads provide reamer stabilization immediately in front of the cutting arms, reducing vibrations and preventing pilot body wear.

Fully customizable

Each body can be fitted with any size of arms within its opening range. Extra arms can be manufactured and delivered worldwide on short notice. Custom bodies can also be manufactured to accommodate for different hole IDs.

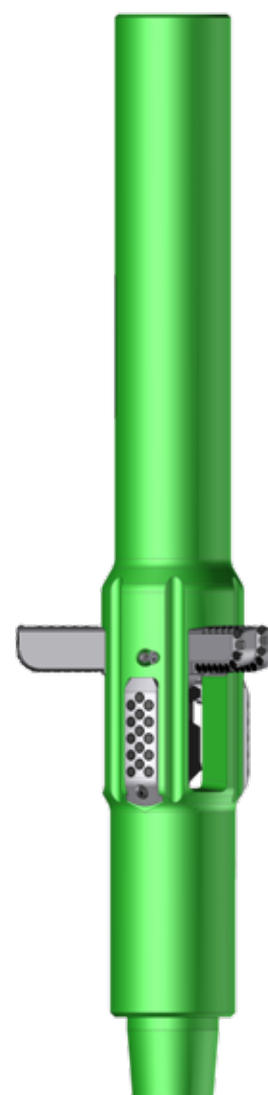

X800 with 19" arms



X-REAMER

Standard dimensions

Type	Body OD	Standard cutter arms	Top	Bottom	Nr. of arms
X450	4 1/2"	5 1/2" - 12"	2 7/8" REG	3 1/2" REG	3
X550	5 1/2"	7" - 14"	3 1/2" IF	3 1/2" REG	3
X575	5 3/4"	7" - 14"	3 1/2" IF	3 1/2" REG	3
X800	8"	9 1/4" - 18"	4 1/2" IF	4 1/2" IF	3
X1200	12"	13 1/2" - 20"	6 5/8" REG	6 5/8" REG	3
X1700	17"	19" - 26"	7 5/8" REG	7 5/8" REG	3
X2600	26"	32" - 54"	7 5/8" REG	7 5/8" REG	3



8" arm for X575

Downhole Innovations, Made in France

HOLE OPENER

Fully field maintainable and intrinsically safe design

Drillstar hole openers have been used worldwide by major drilling contractors for over 30 years. Their proven robustness ensures safe operations while minimizing maintenance and rig costs. Bodies are designed to last a lifetime, and used cutters are easily replaced.

Safe Design

Drillstar Hole openers have been designed by putting safety and reliability first. Oversized arms can withstand heavy WOB, and are mechanically assembled on the body so that welds are not subjected to any direct load during drilling.

Easy maintenance

All sizes are field maintainable, with easy replacement of cutters using only basic tools.

Cutters range

Cutters are made of heat-treated steel, hardfaced with tungsten carbide. Cutter sizes have been widely standardized to minimize customer inventory: for example, 23"-24"-26" and 36" hole openers use the same cutters. They come in 4 types, adapted to a wide range of formation hardness:



TYPE S
for soft formations: milled tooth cutter with wide openings for improved cleaning



TYPE M
for medium formations: our standard, widely used milled tooth cutter.



TYPE H
for hard formations: milled tooth cutter with increased teeth density.



TYPE SH
for very hard formations: tungsten carbide inserts. Inserts shape can be customized as per the customer need: chisel, ballistic, round top, etc



26" hole opener



HOLE OPENER

Standard dimensions

P/N	Hole Size	Pilot Hole	Nr. Cutters	Upper Connection		Lower Connection	
				OD	API Reg. Thread	OD	API Reg. Thread
4505000850	8 1/2"	5 3/4"	2 - 3	6 1/2"	4 1/2"	5"	3 1/2"
4505000950	9 1/2"	6 3/4"	2 - 3	8"	6 5/8"	4 3/4"	3 1/2"
4505001225	12 1/4"	8 1/2"	2 - 3	8"	6 5/8"	5 3/4"	4 1/2"
4505001475	14 3/4"	9 5/8"	3	8"	6 5/8"	8"	6 5/8"
4505001750	17 1/2"	12 1/4"	3	9 1/2"	7 5/8"	8 1/2"	6 5/8"
4505002300	23"	17 1/2"	3	9 1/2 - 10"	7 5/8"	9 1/2"	7 5/8"
4505002600	26"	17 1/2"	3	9 1/2 - 10"	7 5/8"	9 1/2"	7 5/8"
4505003600	36"	26"	3 - 4	10 - 11"	8 5/8"	10"	7 5/8"
4505004200	42"	26"	4	11"	8 5/8"	10 1/2"	7 5/8"

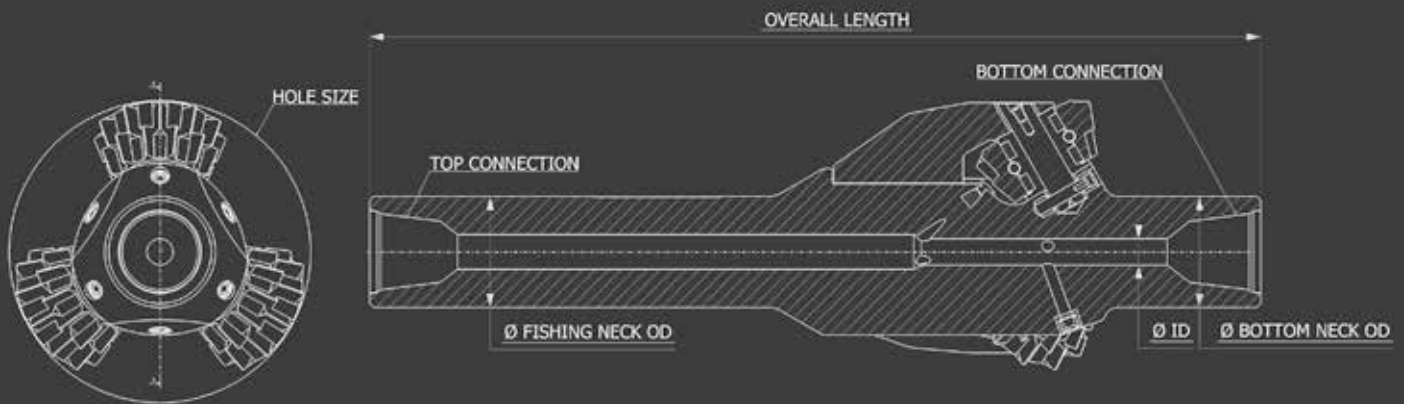

Downhole Innovations, Made in France

PDC HOLE OPENER

Improve your hole opening performances

Drillstar PDC hole opener is a reliable solution for borehole enlargement in sections where PDC bits offer a performance advantage over rock bits.

Built to last

The body is machined out of a single block of heat treated AISI 4145H alloy steel. The unique design of the body ensures maximum strength and durability. It can withstand loads far beyond those involved during normal drilling operations.

During drilling, load is transferred directly from the arms to the body. No axial load is sustained by the pins, substantially reducing the risk of losing parts downhole.

Optimum cleaning is ensured by nozzles strategically positioned between reaming arms.

Advanced exchangeable reaming blades

Reaming blades are designed by Drillstar engineers according to your requirement, based on the same technology used for Drillstar Z-Reamer blades.

Different sizes of blades can be adapted to the same body: for example the 12" OD body can be fitted with optional arms to enlarge up to 20".

Custom sizes of body and arms are available on request.



12 ¼" Pilot PDC Hole Opener fitted with 17 ½" reaming blades



PDC HOLE OPENER

Standard dimensions

Hole Size	Pilot Hole	Body OD	Upper Connection		Lower Connection	
			OD	API Thread	OD	API Thread
8 1/2"	6"	5 3/4"	6 1/2"	4 1/2" IF	5"	3 1/2" IF
12 1/4"	8 1/2"	8 1/4"	8"	6 5/8" REG	5 3/4"	4 1/2" IF
17 1/2"	12 1/4"	12"	9 1/2"	7 5/8" REG	8 1/2"	6 5/8" REG

Custom sizes available on request.

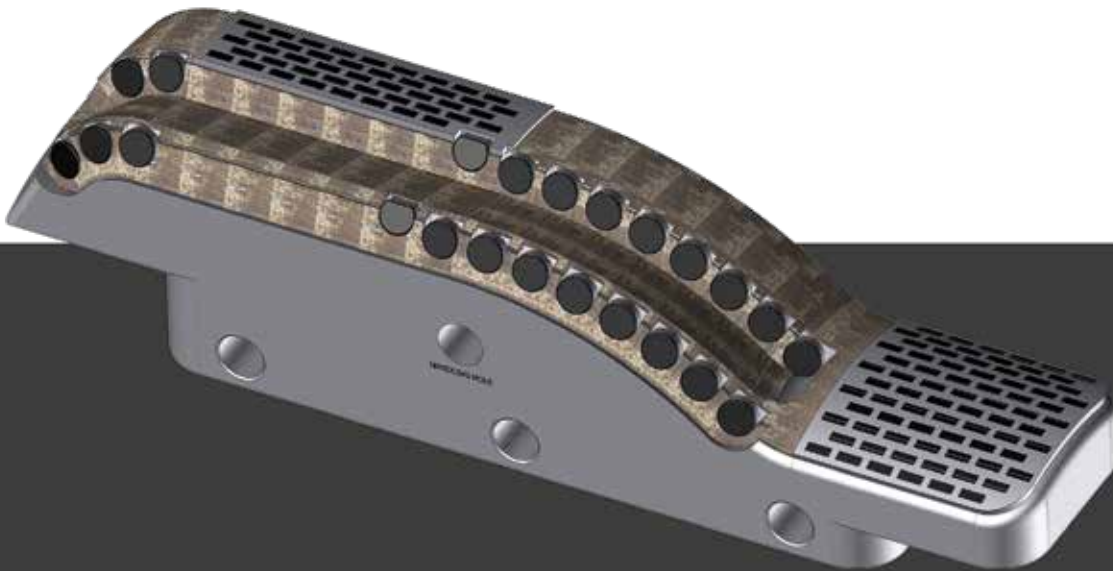

Reaming blades feature long gauges and pads hardfaced to the pilot ID for optimal stabilization.

Downhole Innovations, Made in France

INTEGRAL BLADE STABILIZER

Tailored to your exact need

Drillstar stabilizers are no showroom pieces, they are sturdy, rugged and easy to maintain, exactly what you need in the field. But their main advantage is total customization: we can tailor together the exact stabilizer you need to solve the problem you are facing in the field.

From unusual sizes to TSP hardfacings, blades shape or PDC backreaming inserts, we can deliver a custom solution to many challenges faced with standard stabilizers: gauge & shoulder wear, swelling formations, keyseating, etc. Drillstar stabilizers come in two types : BIB (Body Integral Blade) and SIB (Sleeve Integral Blade).

BIB Stabilizer

Body integral blade stabilizers are cut out of a single piece of fully heat-treated AISI 4145H steel. They are the perfect design for small to medium-size stabilizers (12 1/4" and below), ensuring string integrity while remaining economical.

Hardfacing on the blades can be any of the three types below, or custom-made according to your needs (pressed inserts, trapezoidal blocks, TSP rows, etc.).

Feel free to contact us to find the best design for your project.

Harfacing

Drillstar provides 3 types of standard tungsten carbide hardfacing for stabilizers. In addition, custom hardfacings are also available: TSP, impregnated diamond, pressed TCI, etc. Feel free to enquire for any special need:



TOPLOY

*Copper alloy hardness : 120 to 130 Hv
Calibrated tungsten carbide grains. Hardness:
1400 to 1700 Hv*

Satisfactory behaviour in soft formations. Easy to repair.



TOPFLAME

*Nickel alloy hardness : 430 to 450 Hv
Calibrated tungsten carbide grains
Hardness : 2000 to 2500 Hv*

Excellent behaviour even in hard and abrasive formations or in H2S environment. Adheres well to its support. Sound deposit, without cracks in spite of its extreme hardness.



TOPIC

*Resilient matrix and high resistance to abrasion
Nickel alloy hardness : 400 to 450Hv
Improved adherence between steel blade and hardfacing
Tungsten carbide plates hardness : 1400 to 1700 Hv*

Excellent behaviour even in hard and abrasive formations. Excellent impact strength, resistant to abrasion and H2S corrosion.



8" BIB stabilizer



INTEGRAL BLADE STABILIZER

SIB Stabilizer

SIB (Sleeve Integral Blade) is a unique stabilizer design developed by Drillstar to reduce the risks and costs associated with cracks on large integral stabilizers blades.

Many drilling engineers rely exclusively on body integral blade (BIB) stabilizers. Even though there is no risk of losing blades, repeated heating for rehardfacing may generate cracks in the high tensile alloy steel, resulting in shorter lifespan and higher operating costs.

Drillstar engineering studies and field tests have shown that resistance to the heating cycles involved in rehardfacing is significantly improved if a different grade of steel is used for the blades.

To create a strong connection between the body and the bladed sleeve a nut (A) is set on a thread machined on the body (see sketch). Then the sleeve is preheated and shrink-fitted around the body and nut. The assembly is then completed by welding (B) of the nut (A) and the sleeve (C), both made of the same easy-to-weld steel. Thus, the sleeve can neither turn nor slide, and its strength is comparable to classic BIB designs.

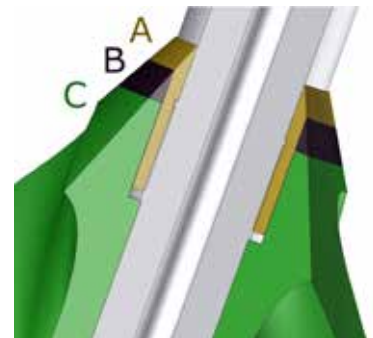

SIB is available for diameters 12 1/4" and above, resulting in longer lifetime and lower operating costs for these expensive large-diameter stabilizers.

- ▲ Hole size and blade O.D. (1)
- ▲ Number of blades and wall contact (2)
- ▲ Blade width (3)
- ▲ Blade angle (4)
- ▲ Shoulder angles (5 and 6)
- ▲ Hardfacing type (7)
- ▲ Fishing neck O.D. (8), I.D. (9) and length (11)
- ▲ Bottom neck length - tong space (12)
- ▲ Bottom (13) and Top (14) connections

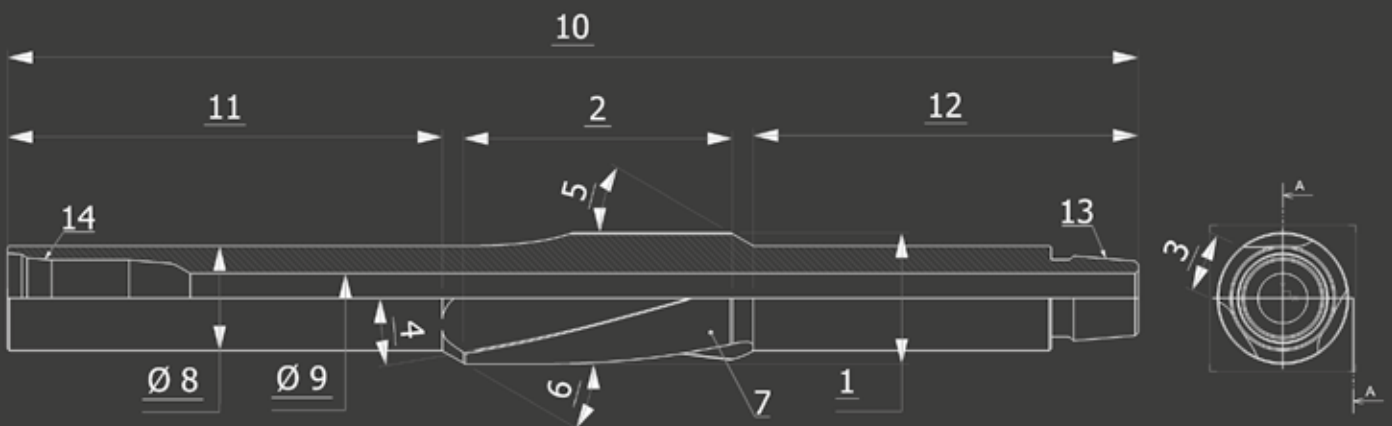

Downhole Innovations, Made in France

ROLLER REAMER

Improved borehole quality, simplified maintenance

The Drillstar roller reamers are available in a wide range of sizes, in both 3-point and 6-point versions. Roller reamers are widely used to reduce BHA-induced torque and improve borehole quality in demanding applications such as long deviated or horizontal sections.

The main effect of replacing spiral stabilizers with roller reamers is reduced friction. As a result, torque is decreased and BHA stability improved.

This helps to reduce adverse effects such as stick-slip and vibrations, and improves weight transfer to the bit.

Fitted with open bearing cutters, they are rugged and easy to maintain in the field.

Reamer Cutters

Drillstar provides 3 types of standard tungsten carbide hardfacing for stabilizers. In addition, custom hardfacings are also available: TSP, impregnated diamond, pressed TCI, etc. Feel free to enquire for any special need:



TYPE S

Suited for a soft and high drillability formation, this cutter's teeth are hardened, carburized and quenched to maximize their lifespan.



TYPE M

Milled-tooth cutter recommended in medium to medium-hard formations. The teeth are milled, machined and hardfaced with tungsten carbide.



TYPE H

This cutter features tungsten carbide inserts (TCI) for hard and semi-abrasive formations.



TYPE VH

Cutter with high TCI density for very hard and abrasive formations.



6" roller reamer



ROLLER REAMER

Standard dimensions

Hole Size	Cutter Size	Max Body Diam.	Body ID	Length	Weight with cutters (lb)
5 5/8"	2"	5"	1"	64"	230
5 7/8"	2"	5"	1"	64"	230
6"	2"	5 1/2"	1 1/4"	64"	260
6 1/8"	2"	5 1/2"	1 1/4"	64"	260
6 1/4"	2"	5 1/2"	1 1/4"	64"	260
6 1/2"	2"	5 3/4"	1 1/2"	64"	260
6 5/8"	2"	5 3/4"	1 1/2"	64"	260
6 3/4"	2"	5 3/4"	1 1/2"	64"	260
8 3/8"	2 5/8"	7 3/4"	1 7/8"	80"	575
8 1/2"	2 3/4"	7 3/4"	1 7/8"	80"	575
8 5/8"	2 3/4"	7 3/4"	1 7/8"	80"	575
8 3/4"	2 3/4"	7 3/4"	1 7/8"	80"	575
12"	4"	10 1/2"	2 13/16"	112"	1088
12 1/4"	4"	10 1/2"	2 13/16"	112"	1088
17 1/2"	5 1/2"	15"	3"	112"	2400
17 3/8"	5 1/2"	15"	3"	112"	2400
26"	7"	22"	3"	122"	3900

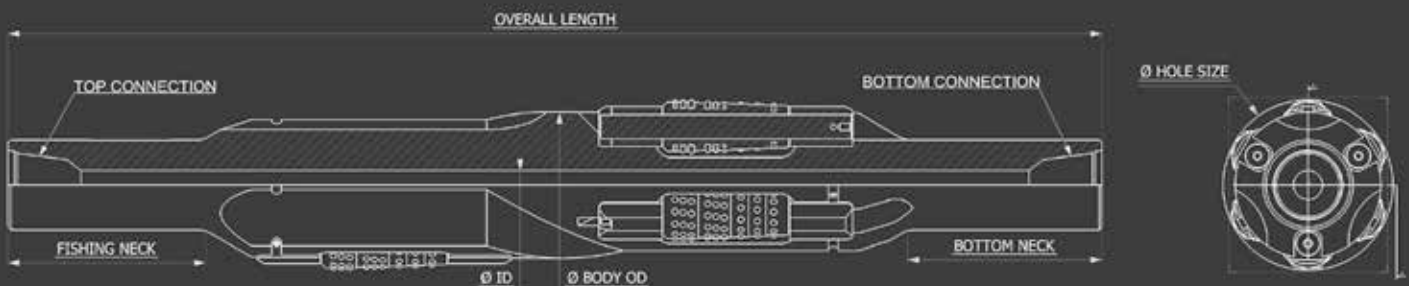

Downhole Innovations, Made in France

BACKGROUND



Drillstar Industries has been serving the oilfield industry since 1977. Originally founded as the manufacturing branch of directional drilling company Top Services, it became a stand-alone company in 1986, when world leader Schlumberger Anadrill acquired Top Services.

Since then, we have grown into an integrated independent manufacturer, providing both a wide range of proprietary tools and full subcontracting solutions to major oil-field suppliers.

Today, we provide equipment and services in two main domains, offering both Drillstar and custom/client designs:

- Drilling and fishing tools.
- Tubing and casing accessories.

Our human size, experience and product quality enable us to serve customers worldwide on tight schedules, a quality which has earned us the trust of major operators and oilfield service companies.

QUALITY CONTROL

Quality is present at every step within Drillstar Industries, from design through production to delivery and after-sales support. Procedures and equipment have been put in place to ensure that the strictest quality requirements of our customers can be met. Controls are implemented throughout this chain to detect and report any discrepancy.



This process has been certified according to the ISO 9001: 2008 standard.

Beyond the requirements of this standard, our manufacturing plant is regularly subjected to quality audits by major oil companies and oilfield equipment manufacturers. Being able to meet the strictest quality requirements in the industry is our best reference.





Av. Joliot-Curie – BP 30061
64148 LONS INDUSPAL cedex - FRANCE
Tel: +33 559 130 100 - Fax: +33 559 621 993
sales@drillstar.fr